

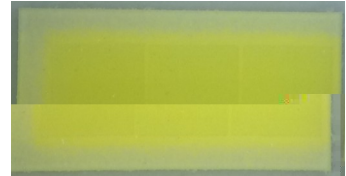

-
-
-
-





Cathode

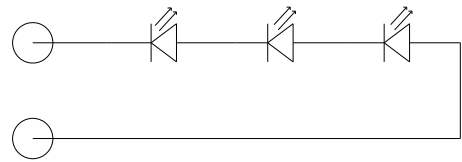

Anode



ATTENTION
OBSERVE PRECAUTIONS
FOR HANDLING
ELECTROSTATIC
DISCHARGE
SENSITIVE
DEVICES





HONGLIZHIHUI
鸿利智汇

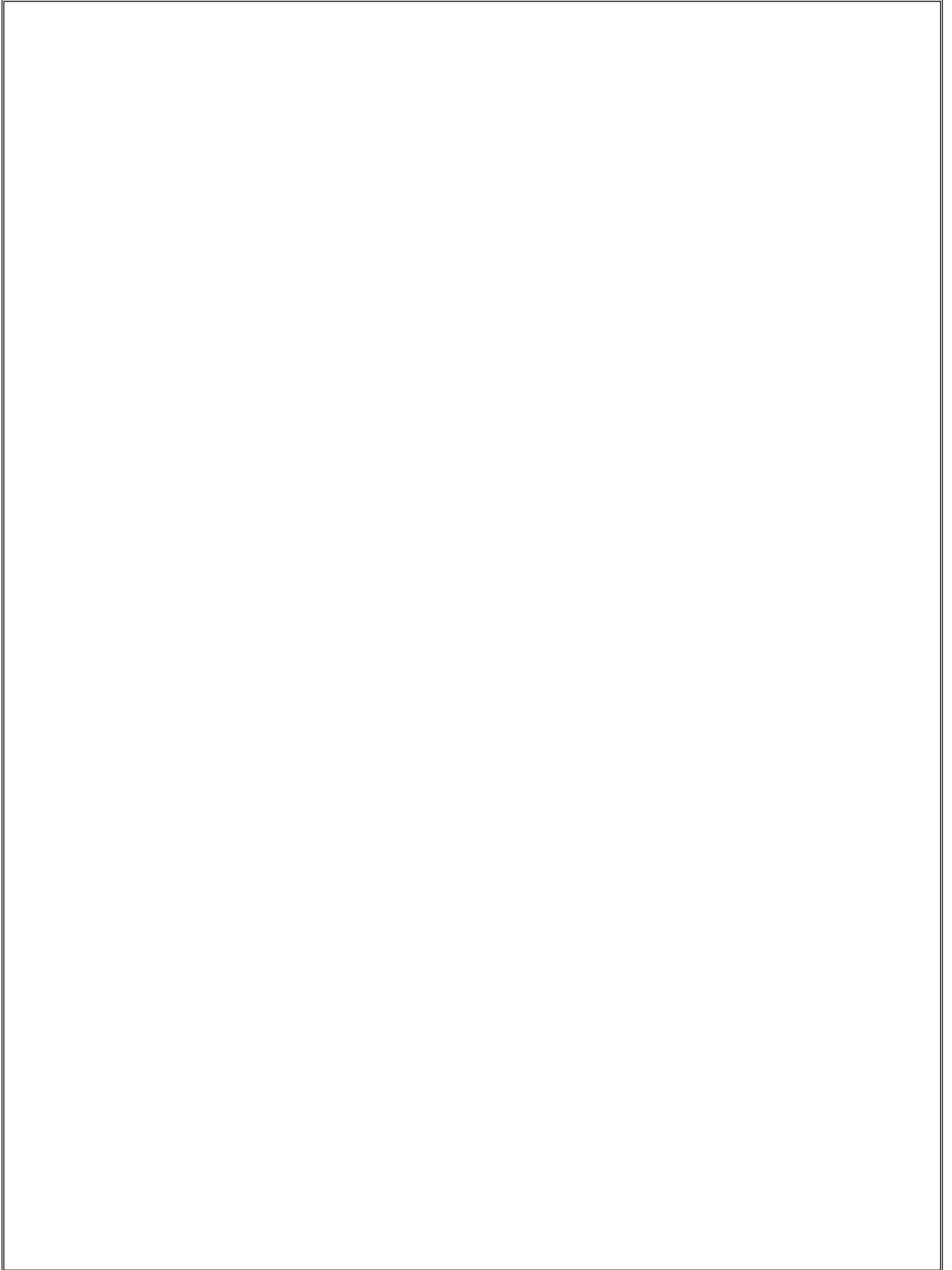



	—		degrees
		°	

注:



注意事项:



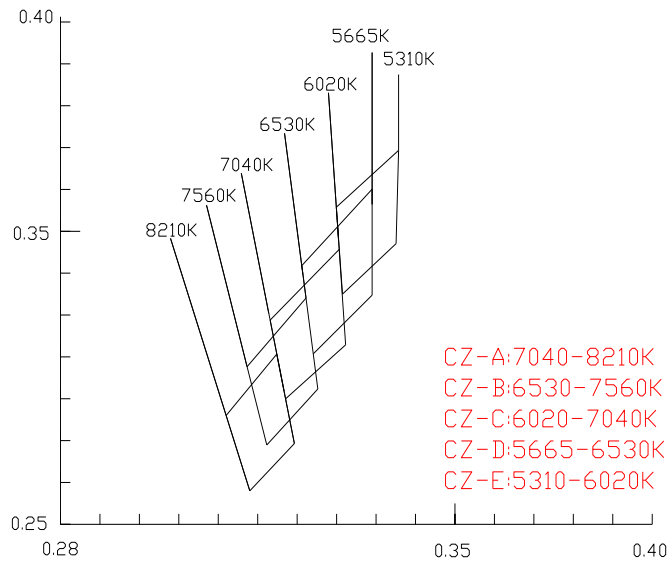

Notes

2.



典型光学/电性特征曲线 ($T_a=25^{\circ}\text{C}$ 除非另有注释)

Relative Luminous Flux-IF

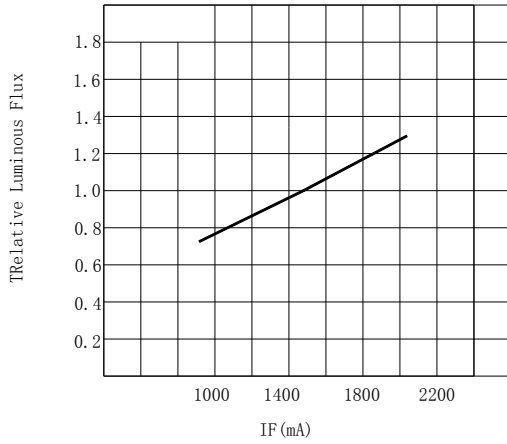

Relative Luminous Flux - Ts(base)

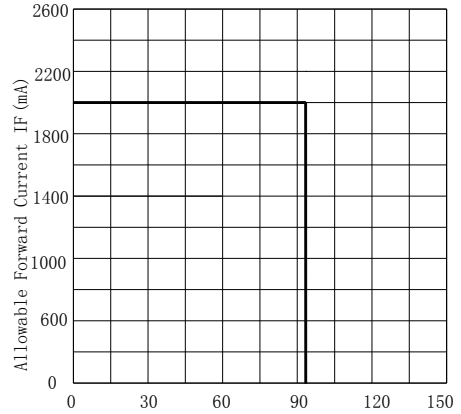

IF - VF

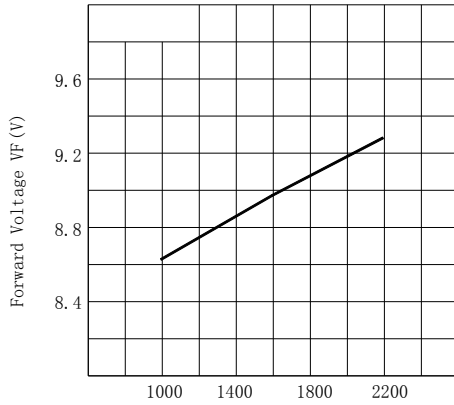

TJ - Relative Flux

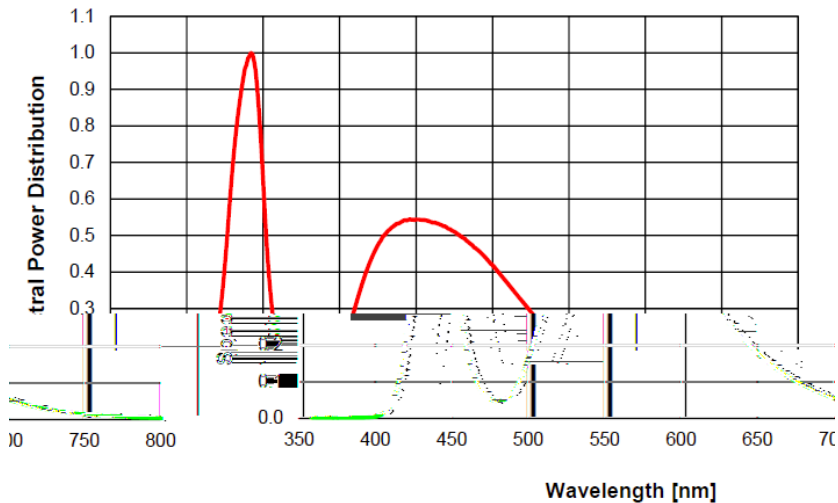
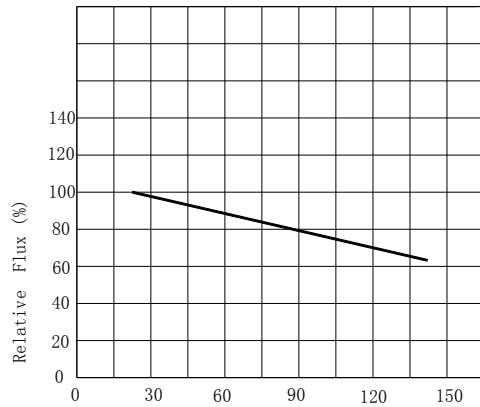

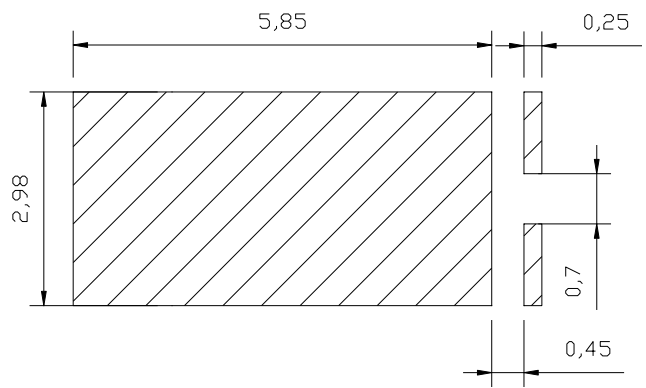
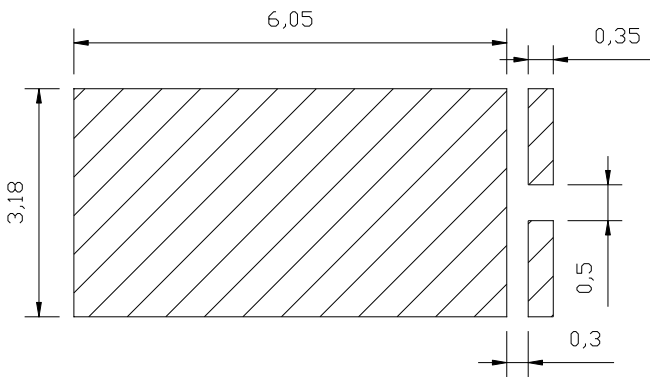
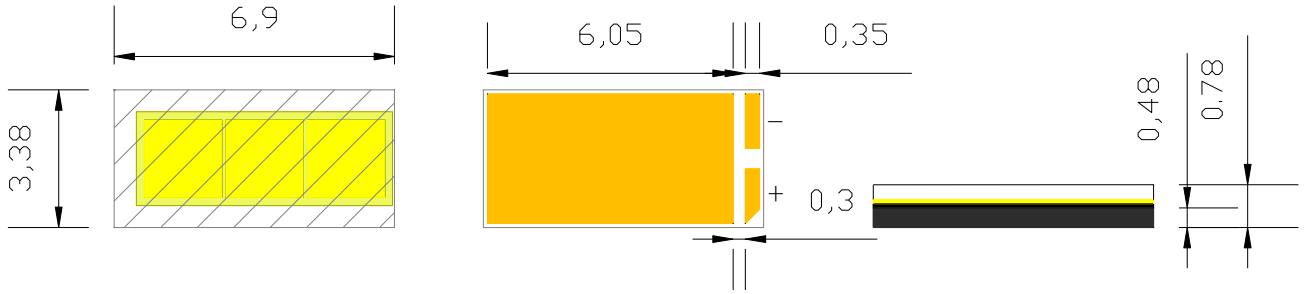



:

Φ



HONGLITRONIC
鸿利智汇

RoHS

TYPE:

QTY:

VIEW:

II#:

ΦV#:

TC#:

XAY#:

CDCL#:

RG#:

DATE:

LOT.NO:

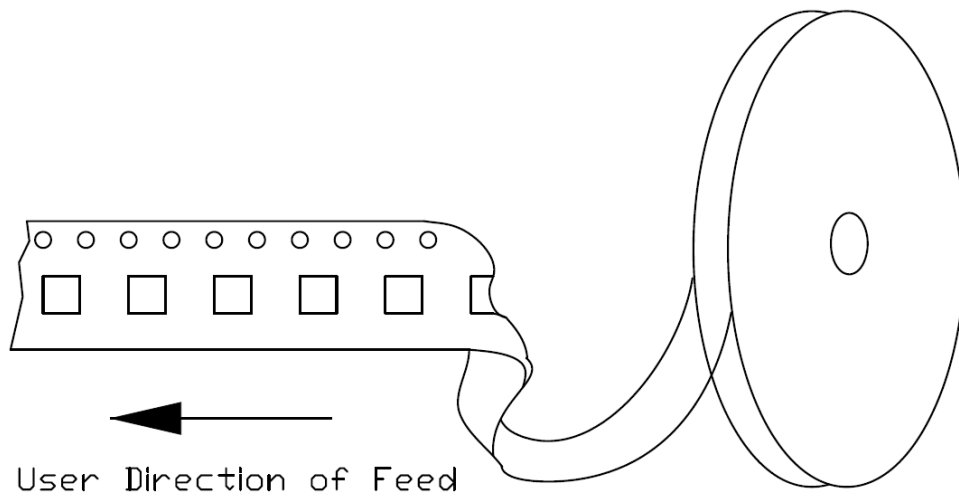



)

)



HONGLIZHIHUI
鸿利智汇

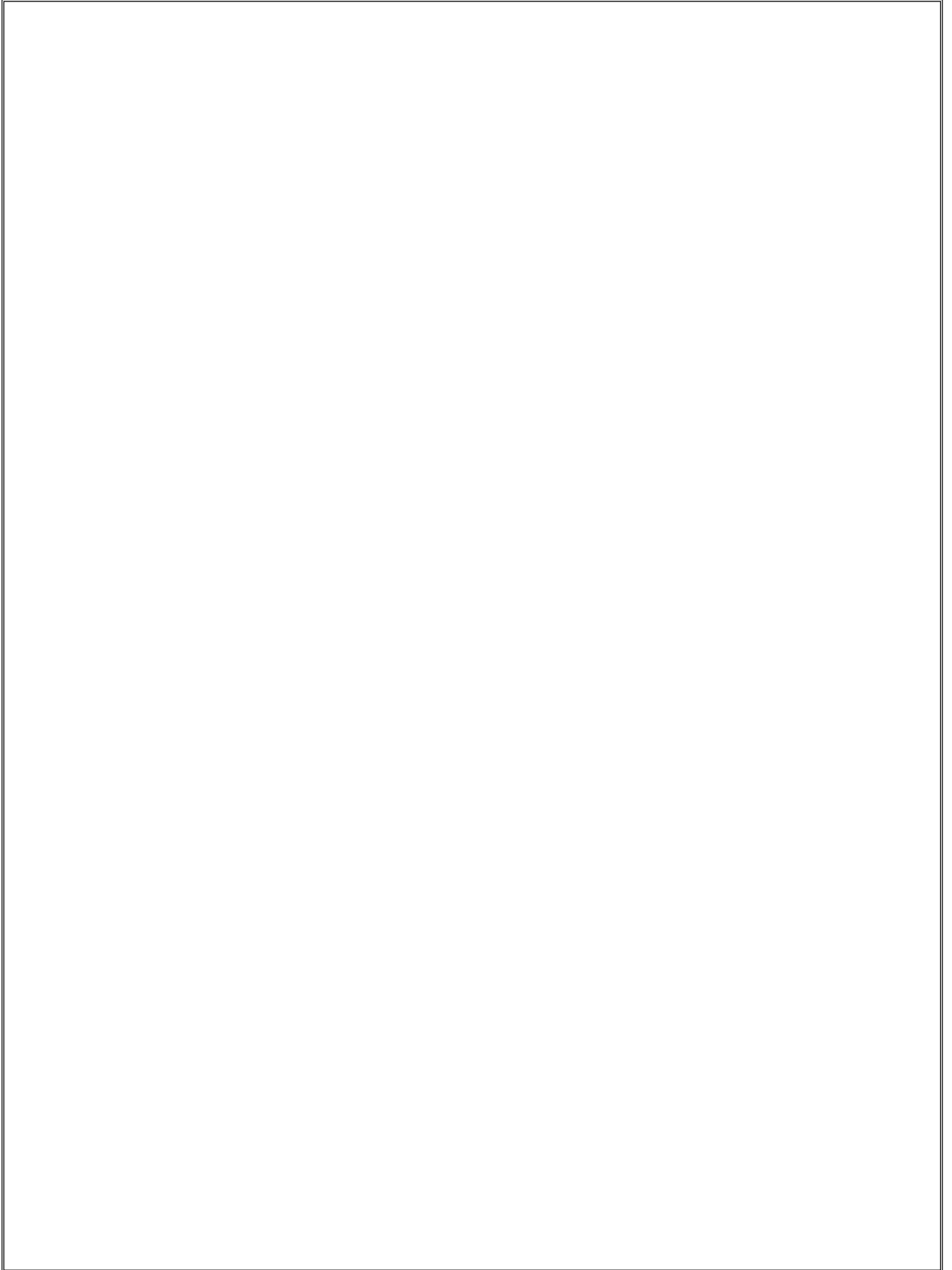



Test	Test Conditions (Test Duration	Decision criteria	Units Failed/ Tested
	25°C 2000mA 1008H		$VF \leq 1.1VF$	
	85°C 2000mA 1008H		$VF \leq 1.1VF$	
	85°C 85%RH 2000mA 1008H		$VF \leq 1.1VF$	
	40°C 100°C			
	40°C 100°C			



HONGLIZHIHUI
鸿利智汇

