







.

.

.

.

/



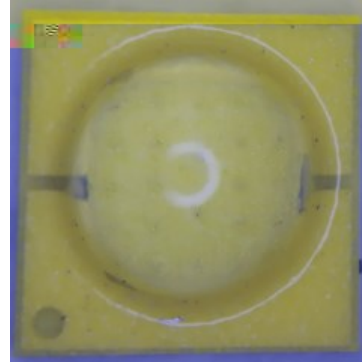

ATTENTION
OBSERVE PRECAUTIONS
FOR HANDLING
ELECTROSTATIC
DISCHARGE
SENSITIVE
DEVICES





-
-
-
-
-

)便携式照明

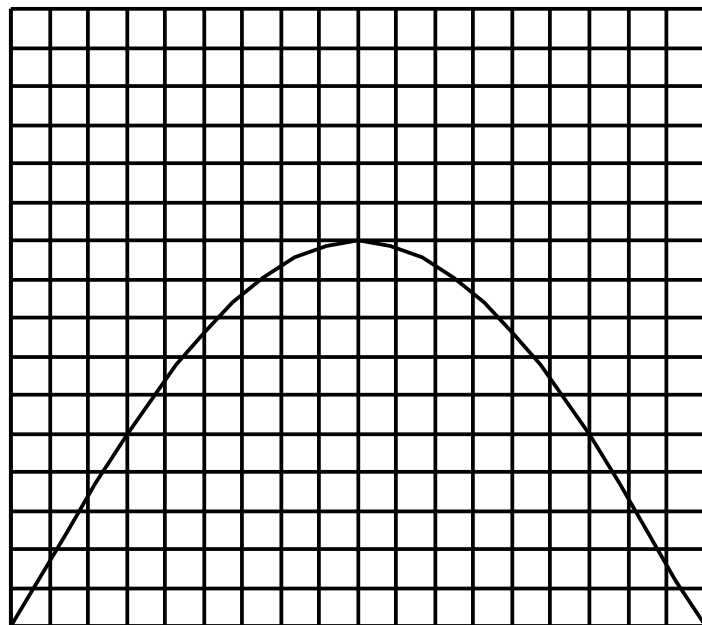
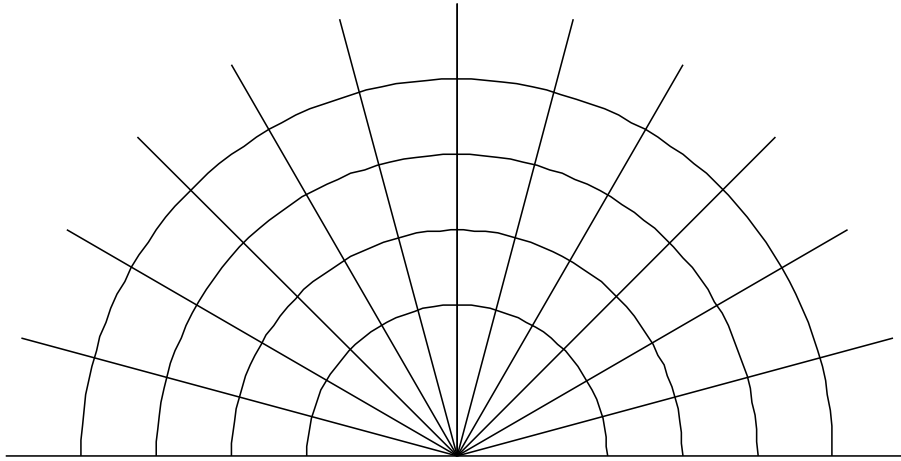



			°
			degrees
		°	°

:

°C,



HONGLI TRONIC
鸿利光电

:





Notes

2.



$T_a=25^{\circ}\text{C}$

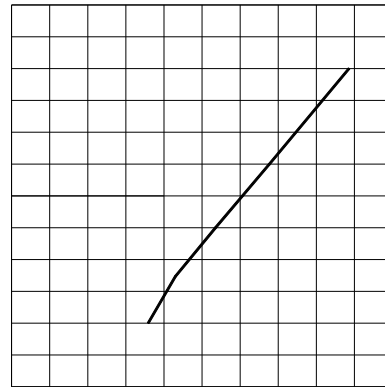
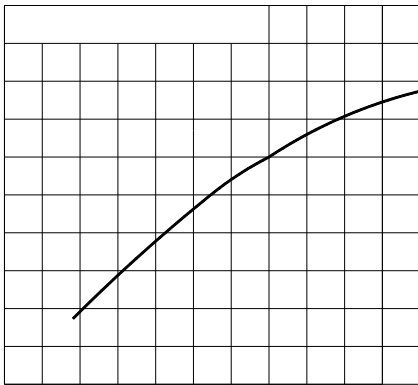

Solder Temperature vs. Relative Luminous Flux

IF=350mA

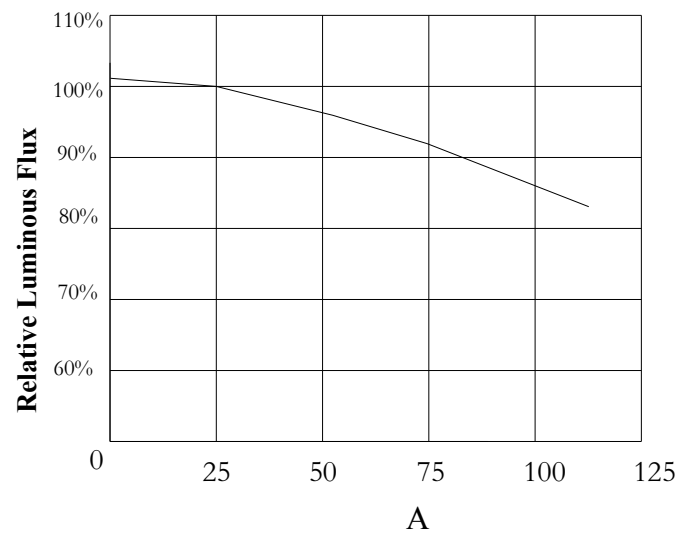
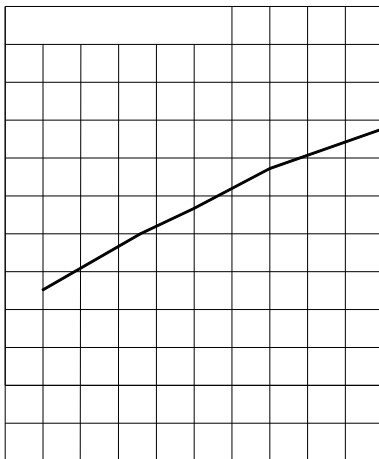



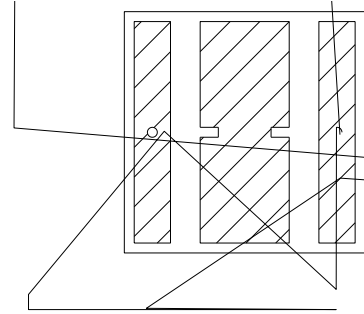
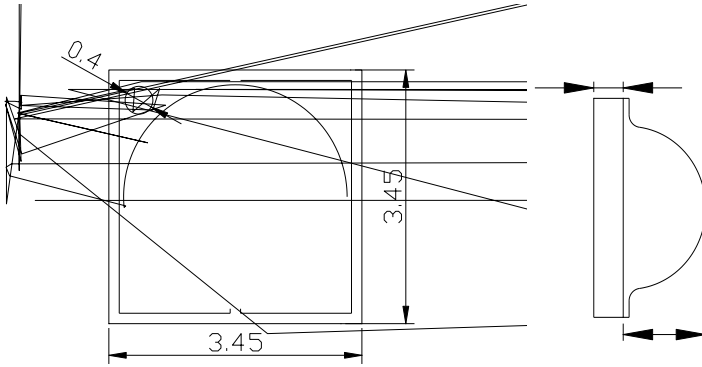

±

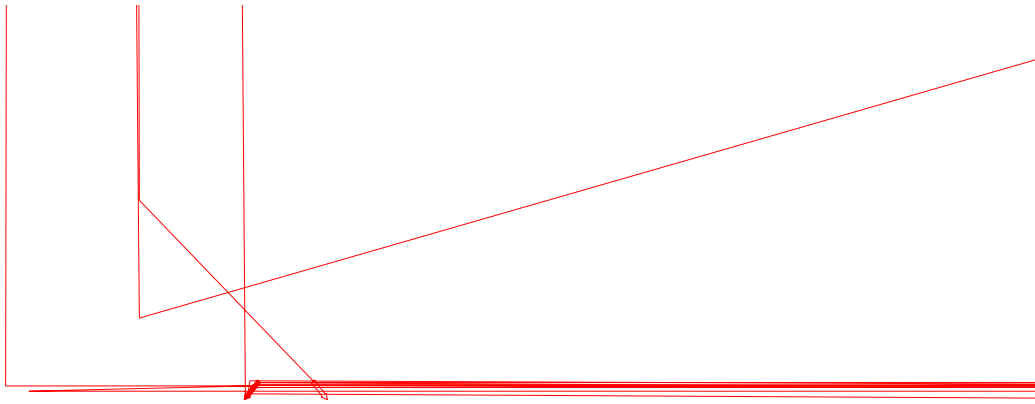



HONGLITRONIC
鸿利光电

:

Φ



HONGLITRONIC
鸿利光电

RoHS

TYPE:

QTY:

VF:

XY:

ΦV:

IF:

TC:

DATE:

LOT.NO:



(1) Reel package (1000 pcs/reel)

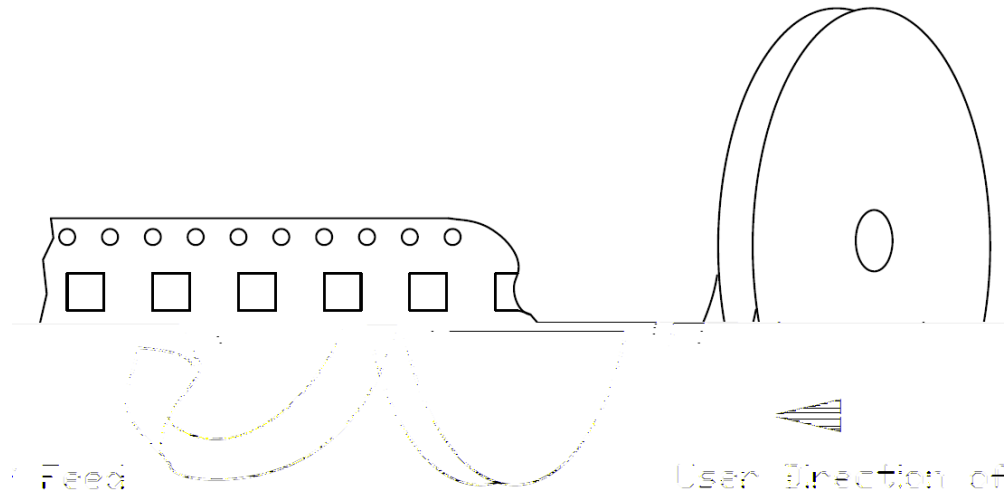
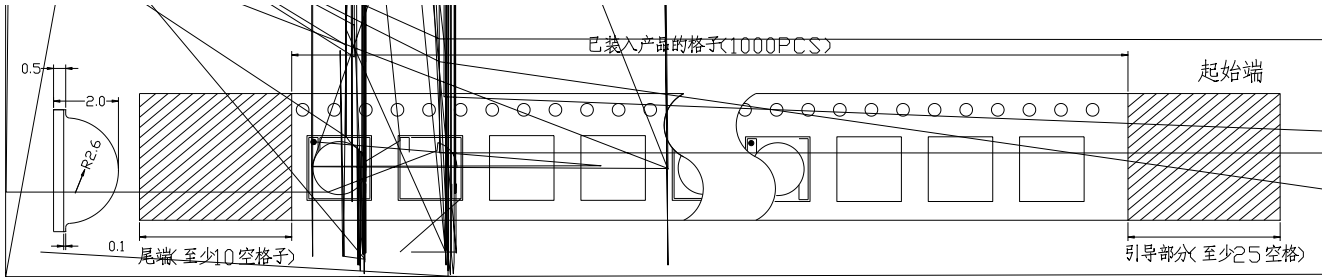

(2) Moisture resistant packaging

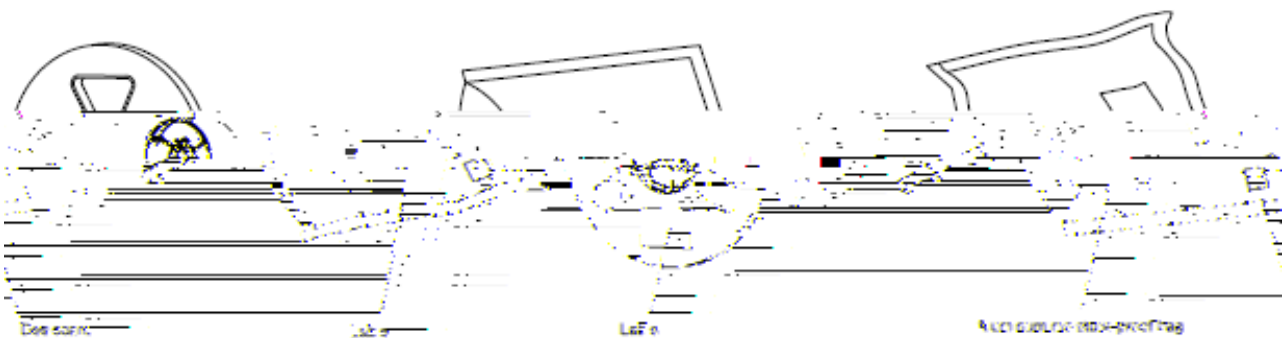



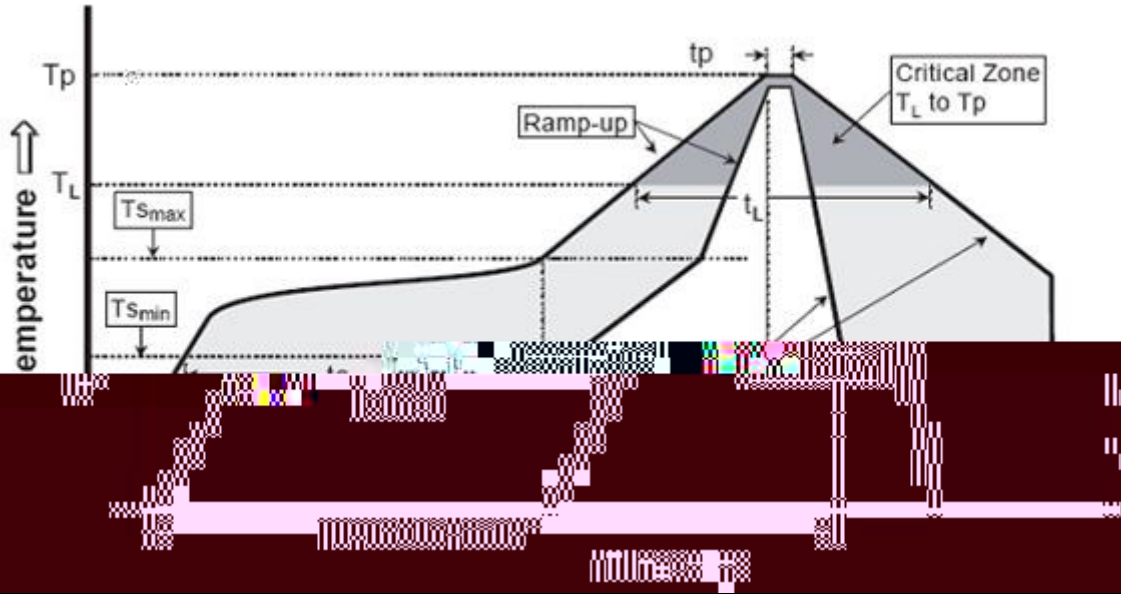

Note:

/5. +/6.

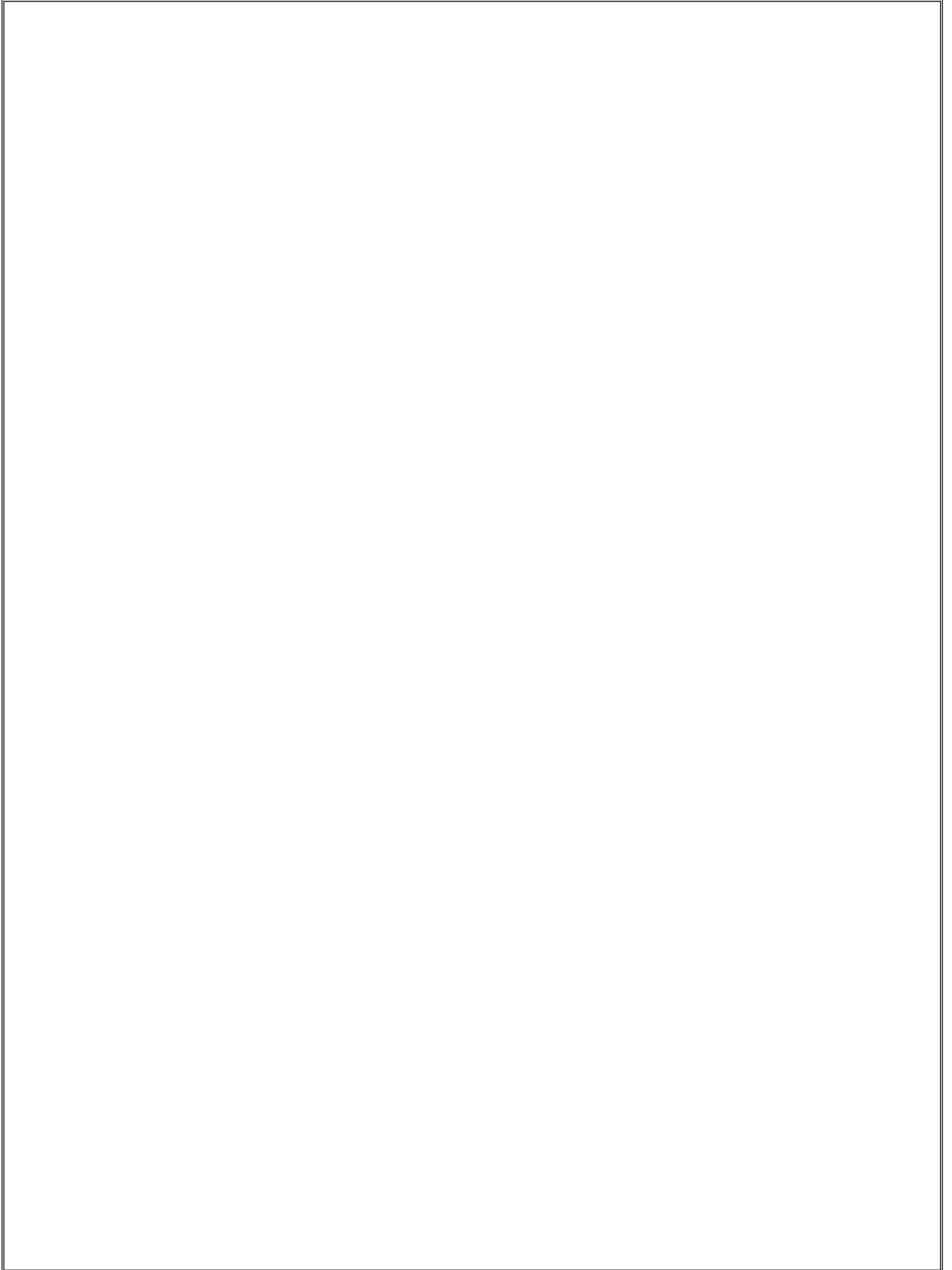



(

(

##

##

##

##

N

+

+

⊕

⊕

A0 0 L 1 M LM

-

, , A0 0 L 1 M LM ,

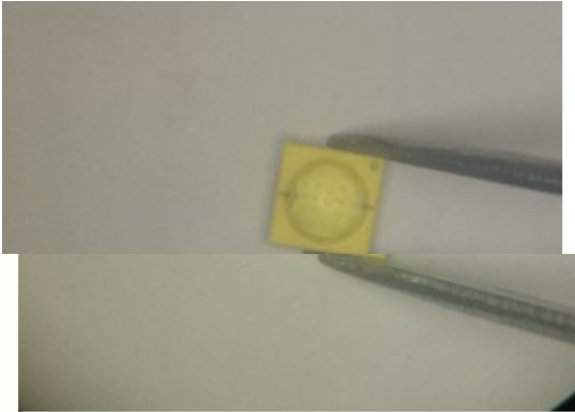

OK

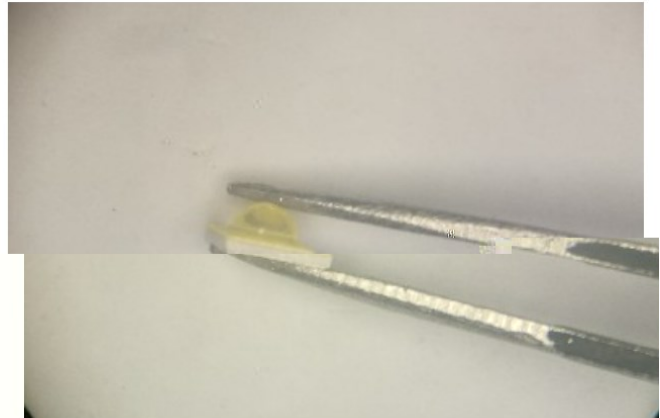

NG

